



Model Number:
EQU1P-4504

RF Components

L-band Passive Equalisers

850 - 2150 MHz

Description specific to each product

- Reciprocal device
- DC block between the 2 ports
- 4dB positive slope

Available with RF connector options:

- 50 Ω SMA
- 50 Ω N-type
- 50 Ω BNC

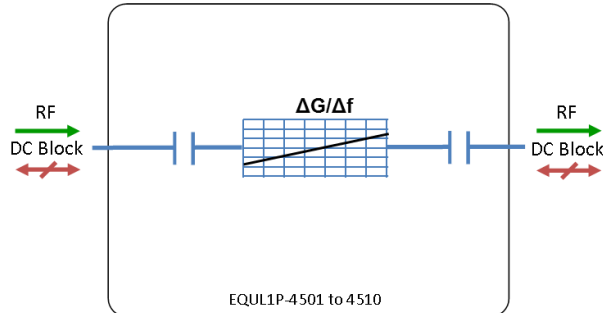

850-2150 MHz
Operating frequency range. L-Band ready



Compact
Housed in rugged compact enclosure



Flexible Mounting
Tapped screw & through hole mounting options



RF Parameters			
EQU1P-4504-xxxx	S5S5	N5N5	B5B5
Frequency Range	850 - 2150 MHz		
RF Connectors	50Ω SMA	50Ω N-Type	50Ω BNC
Mean Insertion Loss (dB)	Typ.	3.0	3.0
	Max.	5.0	5.0
Slope Positive (dB)	4.0 ± 0.6	4.0 ± 0.6	4.0 ± 0.6
Input Return Loss (dB)	Typ.	15	13
	Min	12	10
Output Return Loss (dB)	Typ.	15	13
	Min	12	10

Broadcast



Marine Oil & Gas



SNG & VSAT



Satellite Teleport



Technical specifications and operating parameters

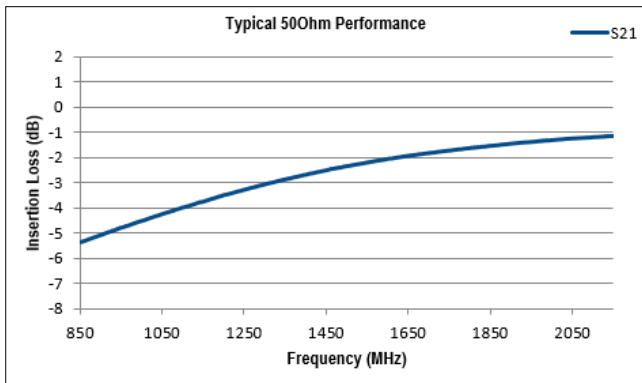

Gain (dB)

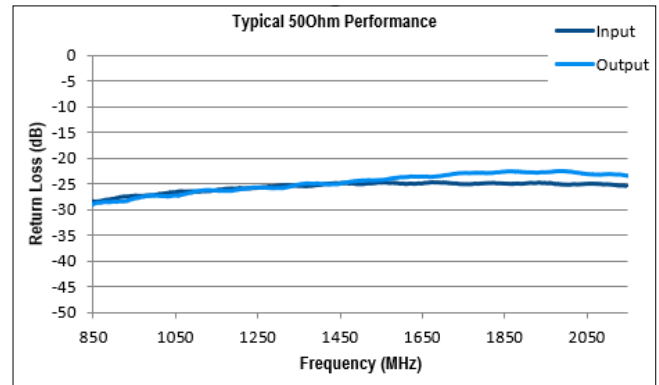

Return Loss (dB)

Environmental		
Operating Temperature		0°C to +45°C
Storage Temperature		-20°C to +75°C
Location		Indoor use Only
Humidity	Max	85% non-condensing
Altitude	Max	10,000 feet

Max Operating Parameters	
Input RF Power	+ 16 dBm (40 mW)
DC Voltage	35 V on any RF port
DC Current	500 mA

! Operation beyond these limits may cause instantaneous and permanent damage.

Physical Dimensions (mm)

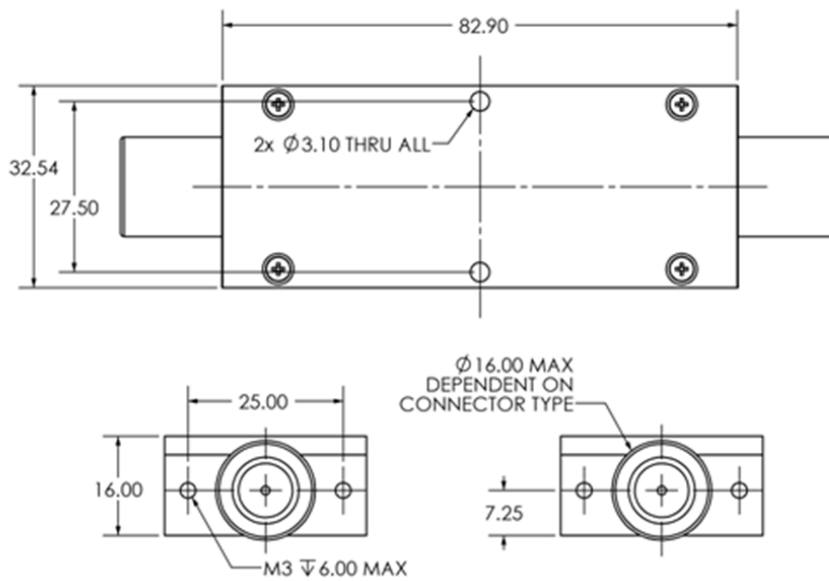

Note: The specification is subject to regular reviews and will be updated from time to time as part of our continuing product development and improved specification accuracy.